

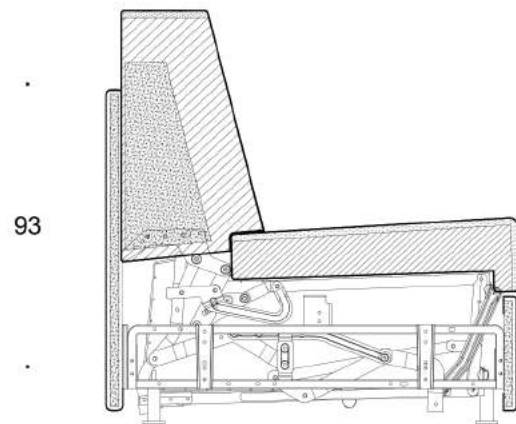

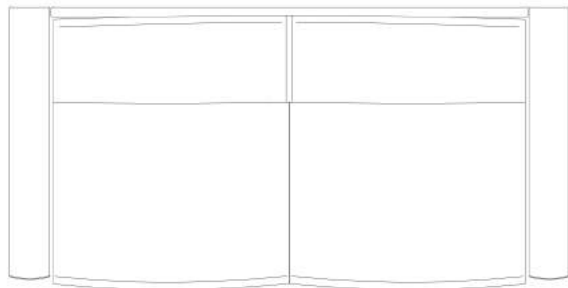

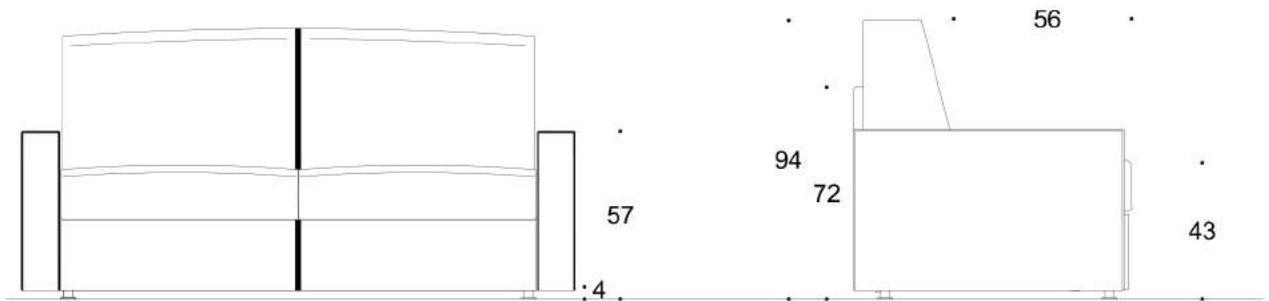

# Break



-  Poliuretano indeformabile portante 25Kg/MC
-  Poliuretano elastico 18Kg/MC
-  Fusto in legno
-  Fibra siliconata 200 gr/mq
-  Poliuretano rivestito
-  Tessuto / Pelle

